

Fiber Optic PIN Photodiode in ST* Receptacle Type OPF472

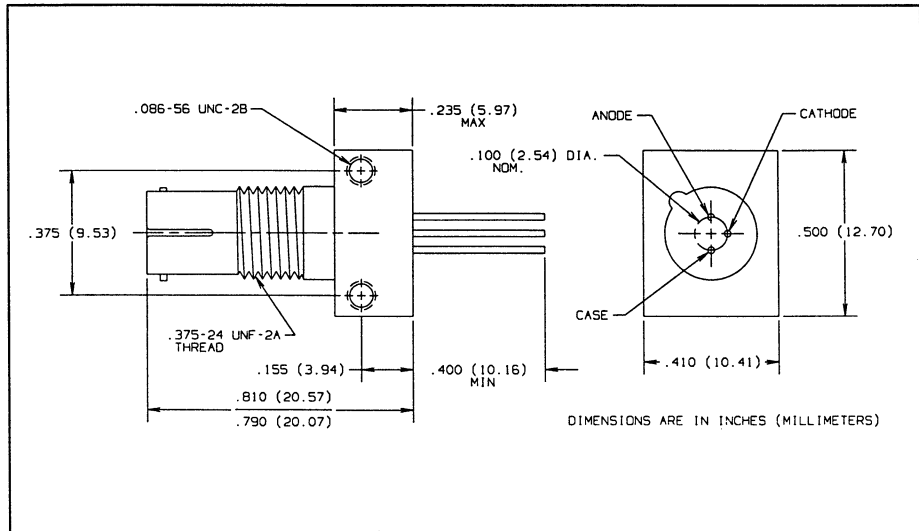
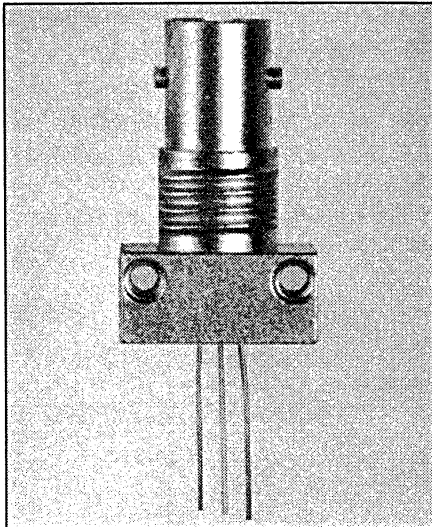

Features

- Component pre-mounted and ready to use
- Pre-tested with fiber to assure performance
- Popular ST style receptacle

Description

The OPF472 consists of a low cost plastic cap PIN photodiode pre-mounted and aligned in an ST receptacle. This configuration is designed for PC board or panel mounting. Includes lock washer and jam nut, two 2-56 screws, and dust cap.

The PIN Photodiodes are designed to interface with multimode optical fibers from 50/125 to 200/300 microns.

*ST is a registered trademark of AT&T.

Absolute Maximum Ratings ($T_A = 25^\circ\text{C}$ unless otherwise noted)

Reverse Voltage	100 VDC
Continuous Power Dissipation	200 mW ⁽¹⁾
Storage Temperature Range	-55 $^\circ\text{C}$ to +100 $^\circ\text{C}$
Operating Temperature Range	-40 $^\circ\text{C}$ to +85 $^\circ\text{C}$
Lead Soldering Temperature [1/16 inch (1.6 mm) from case for 5 sec. with soldering iron]	240 $^\circ\text{C}$ ⁽²⁾

Notes:

- (1) Derate linearly @ 2.0 mW/ $^\circ\text{C}$ above 25 $^\circ\text{C}$.
- (2) RMA flux is recommended. Duration can be extended to 10 sec. max when flow soldering.
- (3) Test @ $V_R = 5\text{ V}$ with 50/125 micron, 0.20 N.A. fiber, @ 10 μm optical power @ 850 nm. Responsivity levels apply to 50 μm , 62.5 μm and 100 μm core optical fibers.
- (4) $R_L = 50\ \Omega$, 10% -90%.

Typical Performance Curves

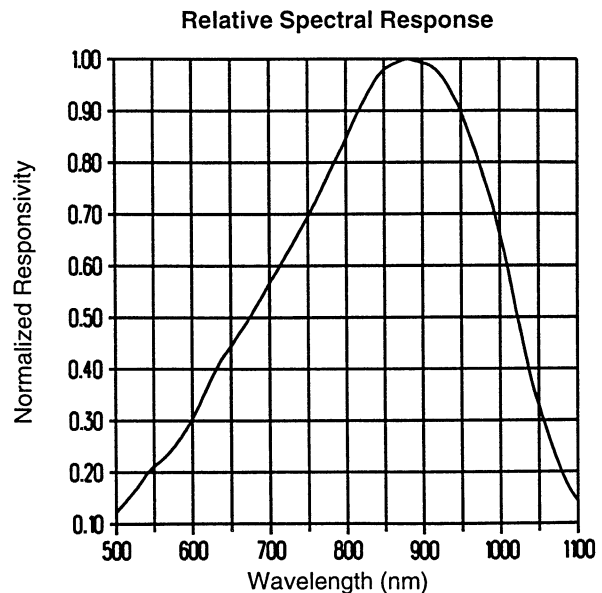

Type OPF472

Electrical Characteristics ($T_A = 25^\circ\text{C}$ unless otherwise noted)

SYMBOL	PARAMETER	MIN	TYP	MAX	UNITS	TEST CONDITIONS
R	Flux Responsivity	0.45	0.55		A/W	$V_R = 5.0\text{ V}^{(3)}$
I_D	Dark Current		0.1	5.0	nA	$V_R = 5.0\text{ V}$
λ_p	Peak Response Wavelength		880		nm	
t_r	Output Rise Time		6.0		ns	$V_R = 15\text{ V}^{(4)}$
C_T	Total Capacitance		3.0		pF	$V_R = 20\text{ V}$

TYPICAL PERFORMANCE CURVES

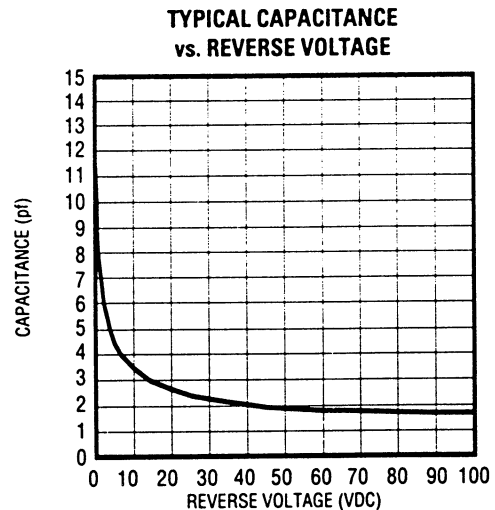
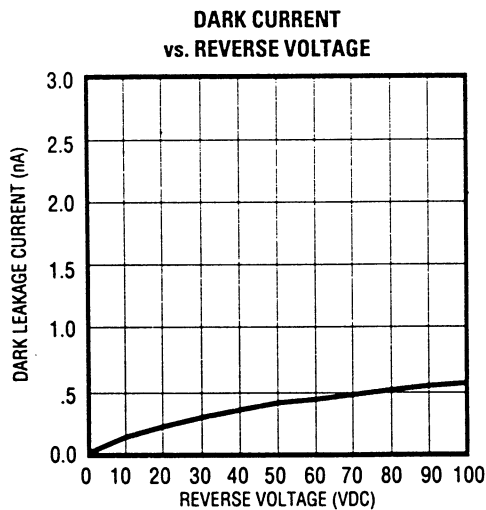
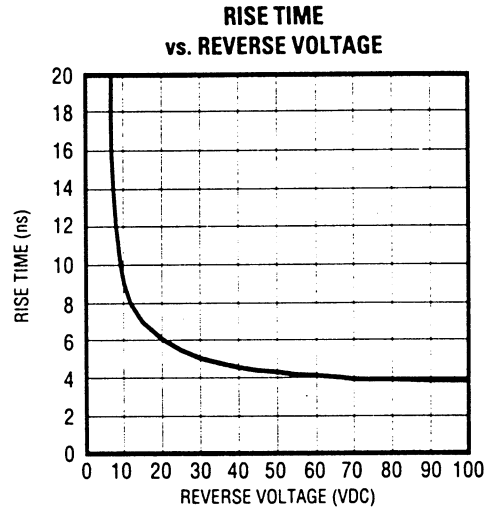
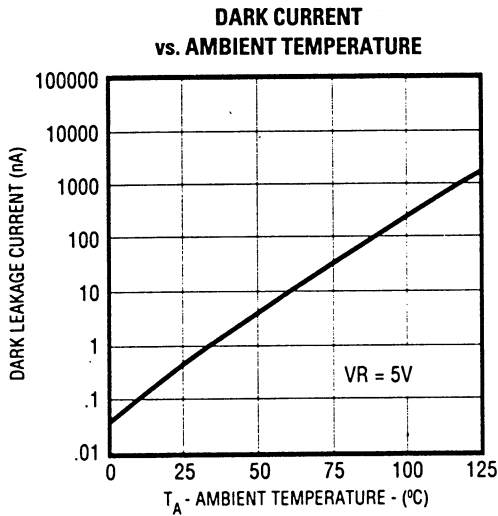

FIBER OPTIC
COMPONENTS